

# OPERATING INSTRUCTIONS AND PARTS MANUAL

## 3/8" PROFESSIONAL AIR IMPACT WRENCH (Twin Hammer) (Model: PAT-103)

Thanks for your purchasing our air tools  
and please read this Instruction Manual carefully  
and thoroughly before operating the tool to do your best jobs.



Revision: 01 (2010)

## WARRANTY AND SERVICE

We (the manufacturers) warrant all products we sell to be free from defects in materials and workmanship for a period of 360 days from the original purchase date. This warranty does not apply to effects due directly or indirectly to abuse, misuse, negligence, normal wear and tear down or improper maintenance, nor shall it apply to any product that has been repaired or altered outside of our facilities. Should any product fail to provide satisfactory service, call your distributor for return authorization but to be accompanied with proof of purchase and an explanation for the return.

We make no other warranty, expressed and/or implied. We shall in no event be liable for death, injuries to persons or property, or for incidental, consequential, indirect or special damages of any nature arising from the sale or use of the products, excepting only the cost or expense of repair and replacement as described above. This warranty gives the customer specific legal rights. Other legal rights may vary from state to state.

### WHO IS COVERED?

This warranty covers only the initial purchaser of the product.

### HOW TO GET SERVICE

The product or part must be returned to the distributor or sales agent for examination. You must provide proof of initial purchase date and an explanation of the complaint must accompany the merchandise. If our inspection discloses a defect, we will repair or replace the product, or refund the purchase price, at our option. We will return the repaired product or replacement at our expense unless it is determined by us that there is no defect, or that the defect resulted from causes not within the scope of our warranty in which case we will, at your direction, dispose of or return the product. In the event you choose to have the product returned, you will be responsible for the shipping and handling costs for the return.

## SAFETY INFORMATION

Please read and understand this entire manual before attempting to assemble, operate or install the product. If you have any questions regarding the product, please contact the distributor or sales agent.

**⚠️ WARNINGS IMPROPER OPERATION OR MAINTENANCE OF THIS PRODUCT COULD RESULT IN SERIOUS INJURY AND PROPERTY DAMAGE. READ AND UNDERSTAND ALL WARNINGS AND OPERATION INSTRUCTIONS BEFORE USING THIS EQUIPMENT. WHEN USING AIR TOOLS, BASIC SAFETY PRECAUTIONS SHOULD ALWAYS BE FOLLOWED TO REDUCE THE RISK OF PERSONAL INJURY.**

<b>⚠️ WARNINGS RISK OF EYE OR HEAD INJURY</b> 	
<b>WHAT COULD HAPPEN</b>	<b>HOW TO PREVENT IT</b>
<ul style="list-style-type: none"> <li>Air powered equipment and power tools are capable of propelling materials such as fasteners, metal chips, sawdust and other debris at high speed which could result in serious eye injury.</li> </ul>	<ul style="list-style-type: none"> <li>Always wear ANSI approved Z87.1 safety glasses with side shields.</li> <li>Never leave operating tool unattached. Disconnect air hose when tool is not in use.</li> </ul>
<ul style="list-style-type: none"> <li>Compressed air can be hazardous. The air system can cause injury to soft tissue areas such as eyes, ears, etc. Particles or objects propelled by the stream can cause injury.</li> </ul>	<ul style="list-style-type: none"> <li>For additional protection use an approved face shield in addition to safety glasses.</li> </ul>
<ul style="list-style-type: none"> <li>Tool attachments can become loose or break and fly apart propelling articles at the operator and others in the work area.</li> </ul>	<ul style="list-style-type: none"> <li>Make sure that any attachments are securely assembled.</li> </ul>

<b>⚠️ WARNINGS RISK OF FIRE OR EXPLOSION</b> 	
<b>WHAT COULD HAPPEN</b>	<b>HOW TO PREVENT IT</b>
<ul style="list-style-type: none"> <li>Abrasive tools such as sanders and grinders, rotating tools such as drills, and impact tools such as nailers, staplers, wrenches, hammers and reciprocating saws are capable of generating sparks, which could result in ignition of flammable materials.</li> </ul>	<ul style="list-style-type: none"> <li>Never operate tools near flammable substances such as gasoline, naphtha, cleaning solvents, etc.</li> <li>Work in a clean, well-ventilated area free of combustible materials.</li> <li>Never use oxygen, carbon dioxide or other bottled gases as a power source for air tools.</li> </ul>
<ul style="list-style-type: none"> <li>Exceeding the maximum pressure rating of tools or accessories could cause an explosion resulting in serious injury.</li> </ul>	<ul style="list-style-type: none"> <li>Use compressed air regulated to a maximum pressure at or below the rated pressure of any attachments.</li> <li>Never connect to an air source that is capable of exceeding 200 psi.</li> <li>Always verify prior to using the tools that the air source has been adjusted to the rated air pressure range.</li> </ul>

<b>⚠️ WARNINGS RISK OF LOSS OF HEARING</b> 	
<b>WHAT COULD HAPPEN</b>	<b>HOW TO PREVENT IT</b>
<ul style="list-style-type: none"> <li>Long term exposure to noise produced from the operation of air tools can lead to permanent hearing loss.</li> </ul>	<ul style="list-style-type: none"> <li>Always wear ANSI S3.19 hearing protection.</li> </ul>

<b>⚠️ WARNINGS INHALATION HAZARD</b> 	
<b>WHAT COULD HAPPEN</b>	<b>HOW TO PREVENT IT</b>
<ul style="list-style-type: none"> <li>Abrasive tools, such as grinders, sanders and cut-off tools generate dust and abrasive materials, which can be harmful to human lungs and respiratory system.</li> </ul>	<ul style="list-style-type: none"> <li>Always wear properly fitting facemask or respirator when using such tools.</li> </ul>
<ul style="list-style-type: none"> <li>Some materials such as adhesives and tar contain chemicals whose vapors could cause serious injury with prolonged exposure.</li> </ul>	<ul style="list-style-type: none"> <li>Always work in a clean, dry, well-ventilated area.</li> </ul>

<b>⚠ WARNINGS RISK OF INJURY</b> 	
<b>WHAT COULD HAPPEN</b>	<b>HOW TO PREVENT IT</b>
<ul style="list-style-type: none"> <li>A tool left unattended, or with the air hose attached, can be activated by unauthorized persons leading to their injury or injury to others.</li> </ul>	<ul style="list-style-type: none"> <li>Remove air hose when tool is not in use and store tool in secure location away from reach of children and untrained users.</li> </ul>
<ul style="list-style-type: none"> <li>Air tools can propel fasteners or other materials throughout the work area.</li> </ul>	<ul style="list-style-type: none"> <li>Use only parts, fasteners and accessories recommended by the manufacturer.</li> <li>Keep work area clean and free of clutter. Keep children and others away from tool while it is in operation.</li> <li>Keep work area well lit.</li> </ul>
<ul style="list-style-type: none"> <li>A wrench or a key that is left attached to a rotating part of the tool increases the risk of personal injury.</li> </ul>	<ul style="list-style-type: none"> <li>Remove adjusting keys and wrenches before turning the tool on.</li> </ul>
<ul style="list-style-type: none"> <li>Using inflator nozzles for duster applications can cause serious injury.</li> </ul>	<ul style="list-style-type: none"> <li><b>DO NOT</b> use inflator nozzles for duster applications.</li> </ul>
<ul style="list-style-type: none"> <li>Air tools can become activated by accident during maintenance or tool changes.</li> </ul>	<ul style="list-style-type: none"> <li>Remove air hose to lubricate or add grinding attachments, sanding discs, drills, etc. to the tool.</li> <li>Never carry the tool by hose.</li> <li>Avoid unintentional starting. Don't carry hook-up tool with finger on trigger.</li> <li>Only an authorized service representative should do repair servicing.</li> </ul>
<ul style="list-style-type: none"> <li>Air tools can cause the workpiece to move upon contact, leading to injury.</li> </ul>	<ul style="list-style-type: none"> <li>Use clamps or other devices to prevent movement.</li> </ul>
<ul style="list-style-type: none"> <li>Loss of control of the tool can lead to injury to self or others.</li> </ul>	<ul style="list-style-type: none"> <li>Never use tool while using drugs or alcohol.</li> <li>Don't overreach. Keep proper footing and balance.</li> <li>Keep handles dry, clean and free from oil/grease.</li> <li>Stay alert. Watch what you are doing. Use common sense. Do not operate tool when you are tired.</li> </ul>
<ul style="list-style-type: none"> <li>Poor quality, improper or damaged tools such as grinding wheels, chisels, sockets, drills, nailers, staplers, etc., can fly apart during operation, propelling particles throughout the work area causing serious injury.</li> </ul>	<ul style="list-style-type: none"> <li>Always use tool attachments rated for the speed of the power tool.</li> <li>Never use tools, which have been dropped, impacted or damaged by use.</li> <li>Use only impact grade sockets on an impact wrench.</li> <li>Do not apply excessive force to the tool; let the tool perform the work.</li> </ul>
<ul style="list-style-type: none"> <li>Fasteners could ricochet or be propelled causing serious injury or property damage.</li> </ul>	<ul style="list-style-type: none"> <li>Never point discharge of tool at self or others.</li> <li>Do not pull trigger unless tool contact safety device is against work surface.</li> <li>Never attempt to drive fasteners into hard surfaces such as steel, concrete, or tile.</li> <li>Avoid driving a fastener on top of another fastener.</li> <li>Position tool carefully so that fasteners will be delivered to the proper location.</li> </ul>
<ul style="list-style-type: none"> <li>Improperly maintained tools and accessories can cause serious injury.</li> </ul>	<ul style="list-style-type: none"> <li>Maintain the tool with care.</li> <li>Keep a cutting tool sharp and clean. A properly maintained tool, with sharp cutting edges, reduces the risk of binding and is easier to control.</li> </ul>
<ul style="list-style-type: none"> <li>There is a risk of bursting if the tool is damaged.</li> </ul>	<ul style="list-style-type: none"> <li>Check for misalignment or binding of moving parts, breakage of parts and any other condition that affects the tool's operation. If damaged, have the tool serviced before using.</li> </ul>
<ul style="list-style-type: none"> <li>Use only accessories identified by the manufacturer to be used with specific tools.</li> </ul>	<ul style="list-style-type: none"> <li>Use of an accessory not intended for use with the specific tools increase the risk of injury to persons.</li> </ul>

<b>⚠ WARNINGS RISK OF ELECTRIC SHOCK</b> 	
<b>WHAT COULD HAPPEN</b>	<b>HOW TO PREVENT IT</b>
<ul style="list-style-type: none"> <li>Using air tools to attach electrical wiring can result in electrocution or death.</li> </ul>	<ul style="list-style-type: none"> <li>Never use nail/staplers to attach electrical wiring while energized.</li> </ul>
<ul style="list-style-type: none"> <li>This tool is not provided with an insulated gripping surface. Contact with a "live" wire will also make exposed metal parts of the tool "live" and can result in electrocution or death.</li> </ul>	<ul style="list-style-type: none"> <li>Avoid body contact with grounded surfaces such as pipes, radiators, ranges and refrigerators. There is an increased risk of electric shock if your body is grounded.</li> </ul>
<ul style="list-style-type: none"> <li>Fasteners coming in contact with hidden electrical wiring could cause electrocution or death.</li> </ul>	<ul style="list-style-type: none"> <li>Thoroughly investigate the workpiece for possible hidden wiring before performing work.</li> </ul>

<b>⚠ WARNINGS RISK OF ENTANGLEMENT</b> 	
<b>WHAT COULD HAPPEN</b>	<b>HOW TO PREVENT IT</b>
<ul style="list-style-type: none"> <li>Tools which contain moving elements, or drive other moving parts, such as grinding wheels, sockets, sanding discs, etc., can become entangled in hair, clothing, jewelry and other loose objects, resulting in severe injury.</li> </ul>	<ul style="list-style-type: none"> <li>Never wear loose fitting clothes or apparel that contains loose straps or ties, etc., which could become entangled in moving parts of the tools.</li> <li>Remove any jewelry, watches, identifications, bracelets, necklaces, etc., which might become caught by the tool.</li> <li>Keep hands away from moving parts. Tie up or cover long hair.</li> <li>Always wear proper fitting clothing and other safety equipment when using the tool.</li> </ul>

<b>⚠ WARNINGS RISK OF CUT OR BURNS</b> 	
<b>WHAT COULD HAPPEN</b>	<b>HOW TO PREVENT IT</b>
<ul style="list-style-type: none"> <li>Tools that cut, shear, drill, staple, punch, chisel, etc. are capable of causing serious injury.</li> </ul>	<ul style="list-style-type: none"> <li>Keep the working part of the tool away from hands and body.</li> </ul>

- ⚠ WARNINGS**
- Replace warning labels if they become obscured or removed.**
  - Do not use this tool for other than its intended use.**
  - Excessive air pressure or too much free rotation will decrease the life of the tool and may cause a hazardous situation.**
  - Check air hose for wear, and keep them away from heat and sharp edges. Do not carry the tool by the air hose.**
  - Slip / trip / fall is a major cause of serious injury or even death. Be aware of excess hose left on your walking way or on the working surface and be aware of the whipping air hose too.**
  - Continuous operation and bad working condition will injure hands. Once hand numbs or aches, operator shall stop the tool for a while for relaxing and re-start the work after recovery. Operator shall immediately see a doctor if such a serious symptom occurs.**

- Keep visitors a safe distance from the work area. keep children away.
- This product may contain one or more chemicals known to cause cancer and birth defects or other reproductive harm. Wash hands after handling.

## AIR SUPPLY

Please refer to the diagram below.

1. Make sure that the air compressor being used for the air tool operation supplies the correct output (CFM).
2. Have the tool in the "off" position when connecting the tool to the air supply.
3. Use normal 90 psi (or ranging from 6.0 to 8.0kg.) air pressure while running the tool. High pressure and unclean air will shorten the tool's life due to faster wear and also may create a hazardous situation.
4. Drain water from air compressor tank daily, as well as any condensation in the air lines. Water in the air line may enter the tool and damage the tool mechanisms at operation.
5. Clean the air inlet filter cartridge weekly. The recommended hook-up procedure can be viewed in the diagram below.
6. Line pressure should be increased accordingly to make up for extra long air hoses (usually over 8 meters). The minimum hose diameter should be 1/4" I.D. and the fittings should have the same inside dimensions. But usually a 3/8" I.D. air hose is recommended for air supply to get the best function of air tool operation.
7. Use proper hoses and fittings. We do not suggest connecting quick change couplings directly to the tool since they may cause failure due to vibration. Instead, add a leader hose and connect coupling between air supply and hose whip.
8. Check hoses for wear before individual use. Make certain that all connections are in security.

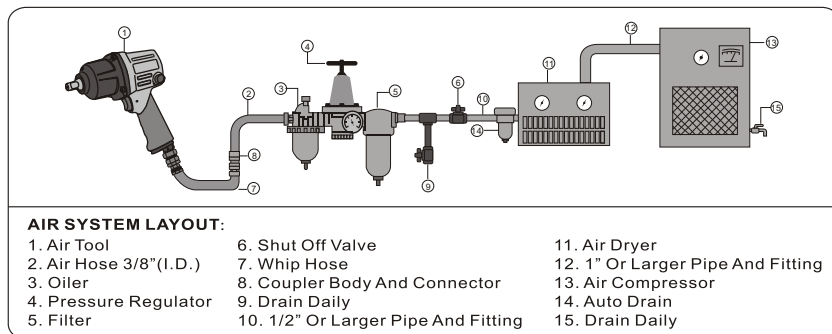

## SPECIFICATIONS

Item number .....	PAT-103
Square drive.....	3/8"
Capacity bolt size.....	1/2 IN. (13 MM)
Free speed .....	8,000 RPM
Max. Torque.....	250 FT-LB(340 N-M)
Average air consumption .....	6 SCFM
Working pressure .....	90 PSI (6.3 BAR)
Air inlet .....	1/4 IN.
Air hose .....	3/8 IN. (inside diameter)
Length x height.....	7.09 x 6.30 IN. (180x160 MM)
Weight .....	1.50 KGS (3.31 LBS)

## PACKAGING CONTENTS

Description	Quantity
3/8" Air Impact Wrench	1
Male Plug	1
Manual	1

## PREPARATION

Before beginning assembly or operation of the product, make sure that all parts are present. Compare the parts with the package contents list. If any part is missing or damaged, do not attempt to assemble, install or operate the product. Contact the distributor or sales agent for replacement.

## OPERATING INSTRUCTIONS

1. Lubricate the tool before operating. See "CARE AND MAINTENANCE" section for oiling instructions.
2. Lubricate the motor by first removing the screw (Part #19) with a hex key (not provided) and then using a grease gun (not provided) to insert the gun nozzle into the grease cape. Several drops of grease are recommended for lubrication. This will protect the motor in good rotating condition and last the tool life. (See Figure 1 & 2)

**Note:** The tool motor should be lubricated once every working day.

3. Remove the air inlet protective cap from the tool and mount a male plug. (See Figure 3 & 4)

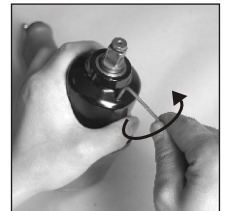

Figure 1



Figure 2

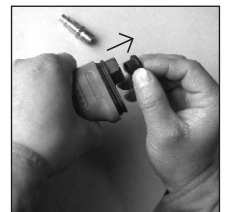

Figure 3

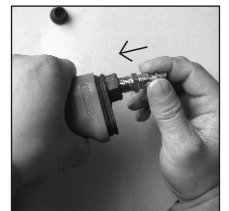

Figure 4

4. Place 2-3 drops of airtool oil (not included) into the male plug before each use. (See Figure 5)
5. Choose the correct impact socket (not provided) as needed and mount it onto the anvil. (See Figure 6)
- WARNING** Only use impact sockets that have an RPM rating equal to or greater than the tool itself.
6. Connect air supply hose to the tool. Set the air pressure at 90 PSI. (See Figure 7)
7. How to install/tighten threaded fasteners  
Push the F/R knob (Part #12) backward. Press the trigger. Then the tool anvil runs clockwise. (See Figure 8 & 9)
8. How to remove/loosen threaded fasteners  
Push the F/R knob (Part #12) forward. Press the trigger. Then the tool anvil runs counterclockwise. (See Figure 10 & 11)

**Note:** This tool features a power regulator valve. Rotate the F/R valve knob (Part #12) until desired output is achieved. The settings 1, 2, 3 are only for reference and do not denote a specific power output. "Setting 1" is the least amount of power while "Setting 3" is the most amount of power. Rotate the F/R valve knob either clockwise or counterclockwise having the triangle mark or hollow line on the knob pointing at any setting to get the desired power. (See Figure 12 & 13)

## CARE AND MAINTENANCE

The tool should be lubricated daily (or before each use) with air tool oil (not included).

**NOTE:** Air tool oil is available at major tool hardware stores. SAE #10 weight oil or sewing machine lubricant or any other high grade turbine oil containing moisture absorbent, rust inhibitors, metal wetting agents and an EP (extreme pressure) additive may be used as a substitute. Do not use detergent oil. During continuous operation, the tool should be oiled every 1 to 2 hours. This may be done using an in-line oiler, or manually. If done manually, proceed as follows:

1. Disconnect the tool from air supply. (See Figure 14)
2. Place a few drops of air tool oil into the air inlet. (See Figure 15)
- NOTE:** Avoid the misuse of thicker oil which may lead to the reduced performance or malfunction.
3. Connect the tool to the air supply. Run the tool without load for a few seconds to distribute the oil through the tool.
- NOTE:** Any excess oil may be propelled from the exhaust area. So keep the tool away in a safe direction.
4. After operating the tool and before storing the tool, disconnect the air hose and place 4 or 5 drops of air tool oil

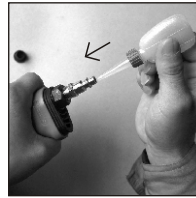

Figure 5

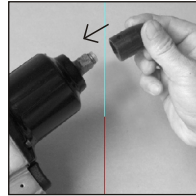

Figure 6

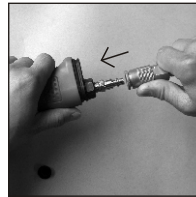

Figure 7

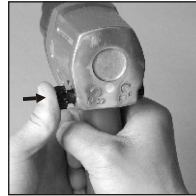

Figure 8

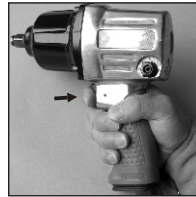

Figure 9

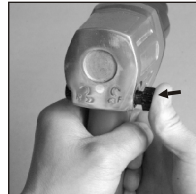

Figure 10

- into the air inlet, then re-connect the air hose and run the tool to evenly distribute the oil throughout the tool for 30 seconds approximately. This will prolong the tool life.
5. Avoid storing the tool in a humid environment which promotes rusting of internal mechanisms. Always oil the tool before storage.
6. When the tool is seriously damaged or out of life, it should be left in a resource recycling can. Never drop it into fire.

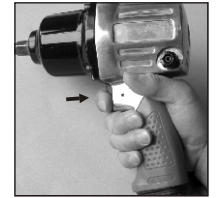

Figure 11

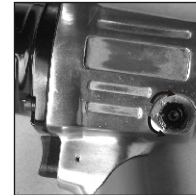

Figure 12

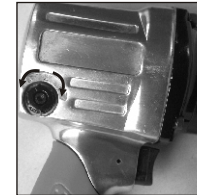

Figure 13

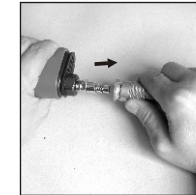

Figure 14



Figure 15

## TROUBLESHOOTING

Problem	Possible Cause	Corrective Action
Tool runs slowly or will not operate	<ol style="list-style-type: none"> <li>1. Grit or gum in tool.</li> <li>2. No oil in tool.</li> <li>3. Low air pressure.</li> <li>4. Air hose leaks.</li> <li>5. Pressure drops.</li> <li>6. Worn rotor blade.</li> <li>7. Moisture blowing out of tool exhaust.</li> </ol>	<ol style="list-style-type: none"> <li>1. Flush the tool with air-tool oil or gums solvent.</li> <li>2. Lubricate the tool according to the lubrication instructions in this manual.</li> <li>3. a. Adjust the regulator on the tool to maximum setting. b. Adjust the compressor regulator to tool maximum of 90 PSIG.</li> <li>4. Tighten and seal hose fittings if leaks are found. Use sealing tape.</li> <li>5. a. Be sure the hoses are the proper size. Long hose or tools using large volumes of air may require a hose with an I.D. of 1/2 in. or larger depending on the total length of the hoses. b. Do not use a multiple number of hoses connected together with quick-connect fittings. This causes additional pressure drops and reduces the tool power. Directly connect the hoses together.</li> <li>6. Replace rotor blade.</li> <li>7. Water in tank: drain tank. (See air compressor manual). Oil tool and run until no water is evident. Oil tool again and run 1-2 seconds.</li> </ol>
Abnormal vibration and/or excessive heat develops in the tool.	Improper lubrication.	Follow proper lubrication procedures in this manual.

**NOTE:** For any special troubles which cannot be settled down by the operator, contact the distributor or sales agent from whom you purchase the tool.



## EXPLODED DIAGRAM AND PARTS LIST

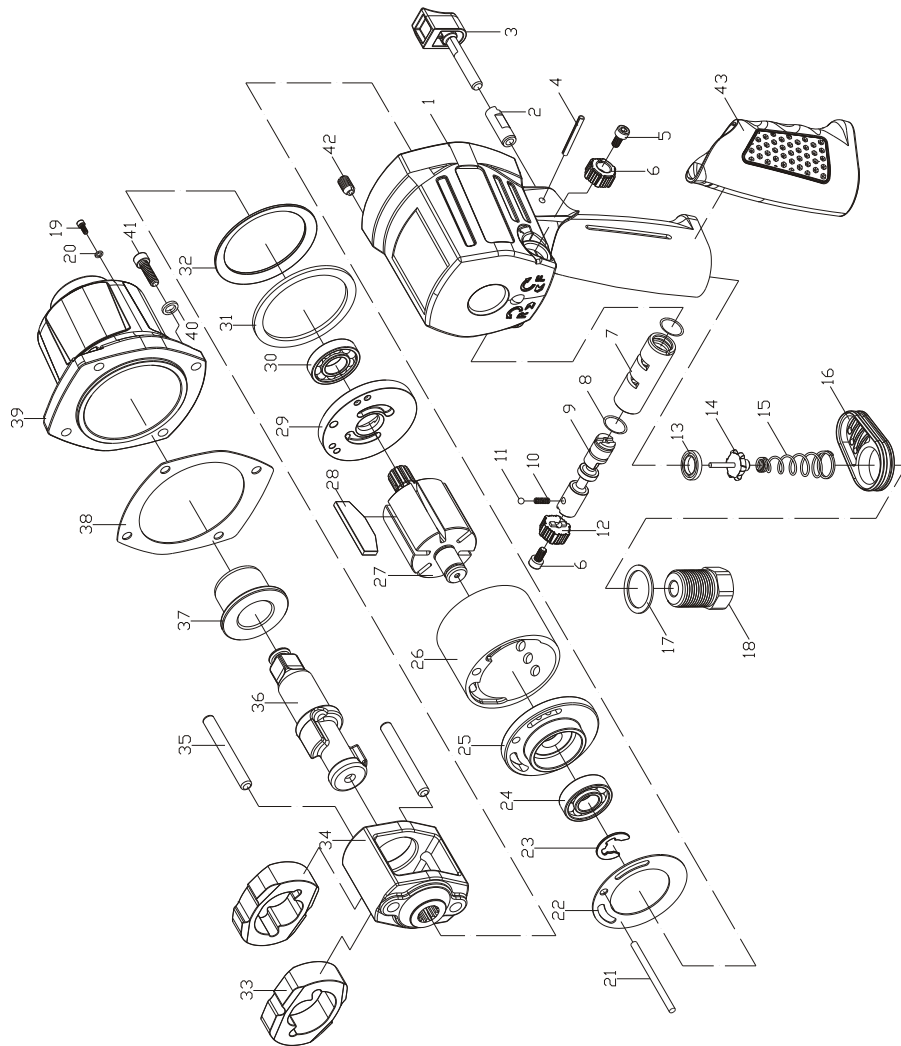

Part No.	Description	Quantity
01	Main housing	1
02	Trigger sleeve	1
03	Trigger	1
04	Trigger bolt	1
05	Screw	2
06	F/R valve knob	1
07	Valve bushing	1
08	O-ring	2
09	Valve	1
10	Spring	1
11	Steel ball	1
12	F/R valve knob	1
13	Valve seat	1
14	Throttle valve	1
15	Valve spring	1
16	Exhaust deflector	1
17	Washer	1
18	Air inlet	1
19	Screw	1
20	O-ring	1
21	Dowel pin	1
22	Gasket	1

Part No.	Description	Quantity
23	Retainer ring	1
24	Rear rotor bearing	1
25	Rear plate	1
26	Cylinder	1
27	Rotor	1
28	Rotor blade	6
29	Front plate	1
30	Bearing	1
31	Washer	1
32	Washer	1
33	Hammer	2
34	Hammer cage	1
35	Hammer pin	2
36	Anvil	1
37	Anvil bushing	1
38	Gasket	1
39	Protector cover	1
40	Spacer	4
41	Cap screw	4
42	Thread bushing	4
43	Soft grip	1

- Contact the distributor or sales agent from whom you purchase the tool for spare parts ordering for any necessary replacement to get continuous use of tool and for extending the tool life.
- When ordering spare parts and components, give each part number and order quantity.

Thank you.